

MX 480

REFUSE HAULER

MODELS
48V



A HIGH-CAPACITY, ZERO-EMISSION REFUSE HAULER.

Solve your trash problems and improve maintenance productivity. This zero-noise, zero-emission refuse hauler makes a great choice for shopping malls, campuses, resorts and more. It holds an impressive 2 cubic yards of trash, reducing the number of return trips needed per shift. The 48V battery pack relies on a durable 48V hydraulic pump to efficiently equalize cells, thereby improving battery life and performance. Optional cab and roll-out battery compartment. A safe, rugged vehicle with unlimited configurations.

MODELS	LOAD CAPACITY (lbs.)	TOWING CAPACITY (lbs.)	PASSENGERS	SPEED (mph)	TURNING RADIUS (in)
48V	1,000	6,000	2	10	130

FEATURES

- 1 Complete console on steering column with multifunction display
- 2 High-efficiency asynchronous AC / Direct Drive motor
- 3 Inclined steering column for a more ergonomic and natural driving posture
- 4 Redesigned bolt-on front bumper and Motrec signature recessed lights
- 5 Premium high-back seats









CONTACT US 1 866 846-3558

MOTREC.COM

SPECIFICATIONS

MX 480

REFUSE HAULER

PERFORMANCE		48V
 LOAD CAPACITY		1,000 lbs - 454 kg
 TOWING CAPACITY		6,000 lbs – 2,722 kg
 SPEED		10 mph – 16 km/h
 TURNING RADIUS		130" - 3,302 mm
 PASSENGERS		2
POWERTRAIN		
MOTOR	Brushless AC motor	15 HP Max (9 HP Continuous)
CONTROLLER	AC Electronic speed controller	✓
DRIVE AXLE	Helical gear differential	✓
BRAKES	Rear hydraulic drum brakes, electromagnetic parking brake with manual hand release, regenerative braking	✓
WHEELS	5.7x8 LRD pneumatic tires	✓
TRANSMISSION	Direct drive	✓
SUSPENSION	Dual leaf springs on front and rear	✓
CHASSIS		
BODY	All-steel unibody construction. Powder Coating.	✓
COLOR	Security orange or federal yellow (optional colors available)	
LIGHTS	LED dual headlights, tail/brake lights and dual back-up lights.	✓
OPERATOR COMPARTMENT		
STEERING	Automotive steering wheel, inclined steering column	✓
SEATS	Two premium seats on slide adjusters	✓
INDICATORS	Multifunction display including speedometer, battery state of charge, hour meter, odometer and fault warnings. Password-protected parameters and monitoring capability.	✓
SAFETY	Deadman seat switch, reverse alarm, horn automatic parking brake	✓
ACCESSORIES	Console on steering column, bolt-on front bumper, DC/DC converter to equalize battery cells, LED charge indicator.	✓

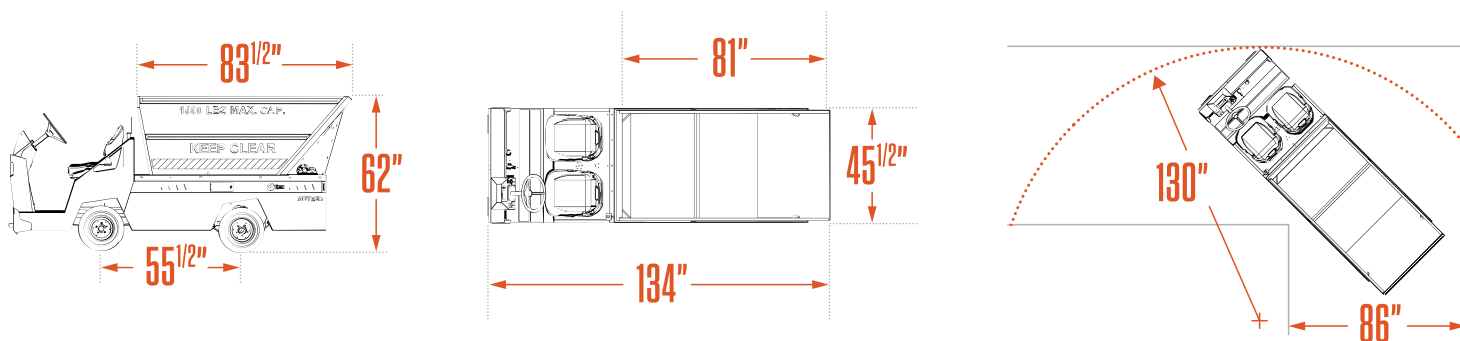

UNBEATABLE VEHICLES BACKED BY UNBEATABLE WARRANTIES

3-Year limited warranty on all Motrec vehicles with AC technology, our MS-260 stock chaser and all Motrec trailers.



1 866 846-3558
MOTREC.COM